

*Betty 140x70*

PREDINSTALACIJA  
PREINSTALLACIJA  
PREINSTALLATION  
VORINSTALLATION

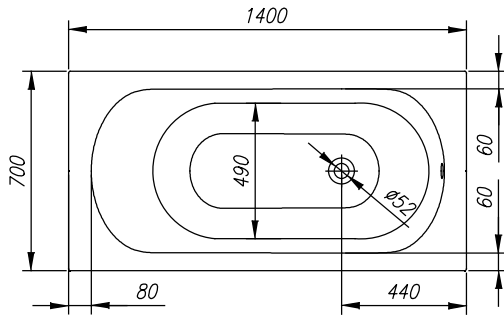
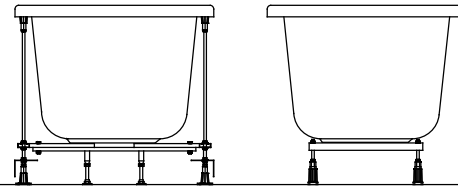
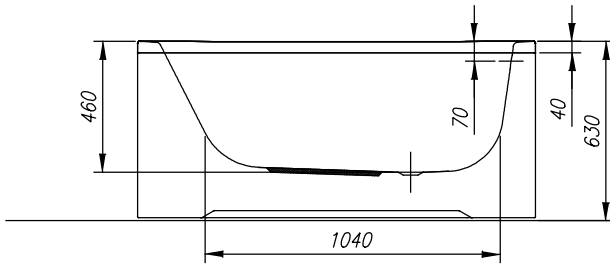
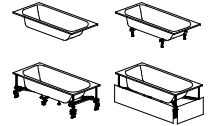

165 L

**VOLUMEN**  
**VOLUMEN**  
**VOLUME**  
**VOLUMEN**

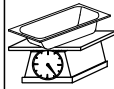

20 kg

**TEŽA**  
**TEŽINA**  
**WEIGHT**  
**GEWICHT**

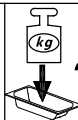

290 kg

**MAX. OBREMENITEV**  
**MAX. OBTEREČENJE**  
**MAX. LOAD**  
**MAX. BELASTUNG**

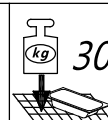

300 kg/m<sup>2</sup>

**OBREMENITEV TAL**  
**OBTEREČENJE PODA**  
**FLOOR LOAD**  
**BODENBELASTUNG**



- Priklop tople in hladne vode 1/2", min 0,2 Mpa, max 0,4 Mpa
- Priključak tople i hladne vode 1/2", min 0,2 Mpa, max 0,4 Mpa
- Connection of hot and cold water 1/2", min 0.2Mpa, max 0.4Mpa
- Anschluss Warm- und Kaltwasser 1/2", min 0,2 Mpa, max 0,4 Mpa



- Prostor za odtok Ø 50 mm
- Mjesto za odtok Ø 50 mm
- Drain spot Ø 50mm
- Abflussplatz Ø 50 mm



- Opcija-obloga
- Opcija-obloga
- Panel - option
- Möglichkeit - Schürze

priporočilo za vgradnjo  
preporuka za ugradnju  
installation recommendation  
Einbauempfehlung

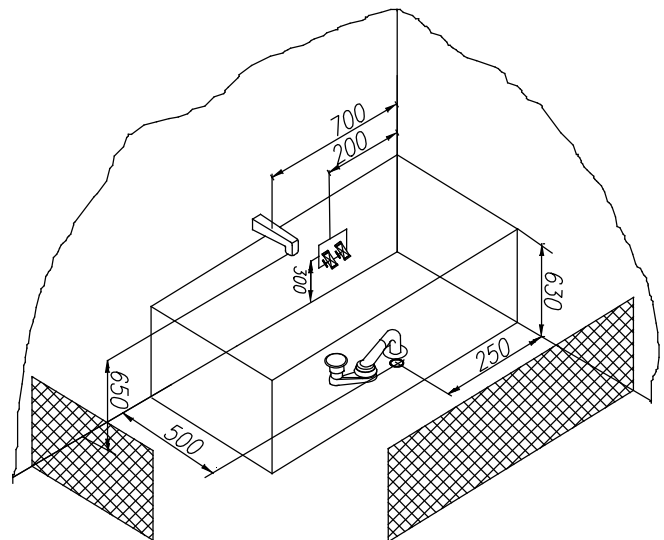

Priporočena prelivna garnitura  
Preporuka prelivne garniture  
Recommended overflow set  
Vorgeschlagene Überlaufgarnitur

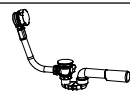

PAL 650

kopalna kad brez oblog - navodilo za vgradnjo  
Kada bez obloge - upute za ugradnju  
Bathtub without panel - installation instructions  
Badewanne ohne Schürze - Einbauanleitung

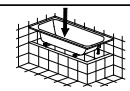

Nr. MK 03

Opcija podnožja za kadi brez obloge  
Varianta postolja za kade bez obloge  
Option of the built-in bathtub base  
Möglichkeit des Sockels für die Badewannen ohne Schürze



Nr. MK 05  
PKK 501

Kopalna kad z oblogo - navodilo za vgradnjo  
Kada s oblogom - upute za ugradnju  
Bathtub with panel - installation instructions  
Badewanne mit Schürze - Einbauanleitung

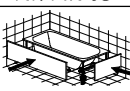

Nr. MK 01

Opcija podnožja za kadi z oblogo  
Varianta postolja za kade sa oblogom  
Option of the bathtub base with panel  
Möglichkeit des Sockels für die Badewannen mit Schürze

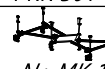

Nr. MK 11  
CM 130-150

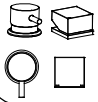

- MEŠALNI VENTIL TOPLA/HLADNA  
- VENTIL ZA MIEŠANJE TOPLO/HLADNO  
- MIXING VALVE HOT/COLD  
- MISCHVENTIL WARM/KALT

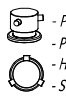

- PREKLOPNIK ROČNA PRHA/IZLIV  
- PREKIDAČ ZA RUČNI TUŠ/IZLJEV  
- HAND SHOWER/SPOUT SELECTOR SWITCH  
- SCHALTER FÜR HANDBRAUSE/AUSLAUF

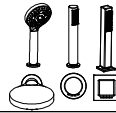

- ROČNA PRHA  
- RUČNI TUŠ  
- HAND SHOWER  
- HANDBRAUSE

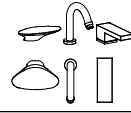

- IZLIV  
- IZLJEVNIK  
- SPOUT  
- AUSLAUF

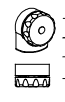

- IZLIV NA PRELIVNI GARNITURI  
- IZLJEV NA PRELJEVNOM SETU  
- SPOUT ON THE OVERFLOW SET  
- AUSLAUF AN DER ÜBERLAUF GARNITUR

- OPCIJA ENOROČNA ARMATURA GEYSER
- OPCIJA JEDNORUČNA ARMATURA GEYSER
- OPTION ONE HAND FITTING GEYSER
- MÖGLICHKEIT EINWEG-ARMATUR GEYSER

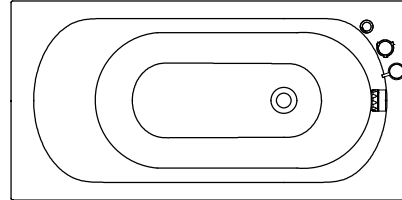
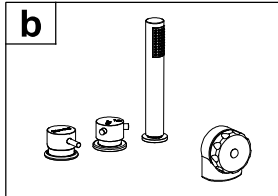

- OPCIJA ENOROČNA ARMATURA RAINDROP
- OPCIJA JEDNORUČNA ARMATURA RAINDROP
- OPTION ONE HAND FITTING RAINDROP
- MÖGLICHKEIT EINWEG-ARMATUR RAINDROP

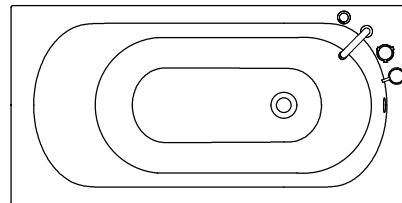
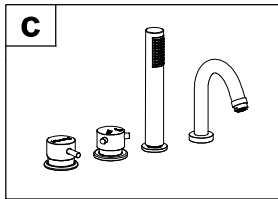

- OPCIJA ENOROČNA ARMATURA STREAM ( CHR / BLACK )
- OPCIJA JEDNORUČNA ARMATURA STREAM ( CHR / BLACK )
- OPTION ONE HAND FITTING STREAM ( CHR / BLACK )
- MÖGLICHKEIT EINWEG-ARMATUR STREAM ( CHR / BLACK )

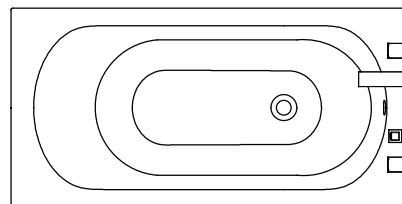
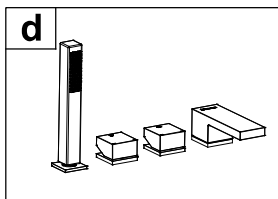

V NAVEDENO KOPALNO KAD NE VGRAJUJEMO MASAŽNIH SISTEMOV

U NAVEDENU KUPAONSKU KADU NE UGRAĐUJEMO MASAŽNIH SISTEMOV

WE DO NOT INSTALL MASSAGE SYSTEMS IN THE GIVEN BATHTUB

IN DER ANGEGEBENEN BADEWANNE WERDEN MASSAGESYSTEMEN NICHT EINGEBAUT

OPCIJE OPCIJE OPTIONS MÖGLICHKEITEN

- POLOŽAJ OBLOG NA KOPALNI KADI
- POZICIJA OBLOGE NA KADI
- PANEL POSITIONS ON THE BATH
- POSITION DER SHÜRZE FÜR BADEWANNE

